

The logo consists of the letters 'R&F' in a white, classic serif font, set against a solid black rectangular background. A small registered trademark symbol (®) is located to the right of the 'F'.

R&F[®]

The text 'HANDMADE PAINTS' is written in a white, clean, sans-serif font, centered within a solid olive-green rectangular background.

HANDMADE
PAINTS

The text 'BASIC ENCAUSTIC MANUAL' is written in a white, clean, sans-serif font, centered at the bottom of the page.

BASIC ENCAUSTIC MANUAL

Basics of Working with Encaustic

Encaustic paint is composed of beeswax, damar resin, and pigment. Because encaustic is impervious to moisture, it is one of the most durable artists' paints. Beeswax alone is relatively soft. Resin is added to raise the melting temperature of the wax and to give it hardness. This makes it more durable and able to take a higher polish.



Since encaustic paint is beeswax-based it needs to be kept molten on a heated palette to be applied to a ground. The basic technique of encaustic is to melt the paint, apply it, and then fuse (or re-heat) the surface to bond each layer. The word encaustic comes from the Greek word *enkaiein*, meaning to burn in, which refers to this process.

One of the many benefits of working with encaustic paint is that it can be polished to a high gloss, carved, scraped, layered, collaged, dipped, cast, modeled, sculpted, textured, and combined with oil. The paint cools almost immediately, so that there is no drying time, yet it can always be reworked. An additional advantage is that no solvents are necessary.

Basic Set-up Suggestions

- You will need a clean level worktable to put a heated palette on. When setting up your worktable take into consideration the space that your palette will occupy and give yourself extra room for additional materials.
- You will want to make sure that your work area has proper ventilation. Exhaust fans in windows, cross-ventilation, or a studio ventilation system are all good options. It is important that you have a source of fresh air in your workspace.
- It will be imperative that you have adequate electrical outlets available for use. Consider that you will have a palette, a heat gun, and/or other tools that will require electricity and it will be helpful to position your workspace accordingly.
- Keep in mind that anytime you use heated tools/equipment it is recommended that you have a burn kit and a fire extinguisher on-hand for safety purposes.

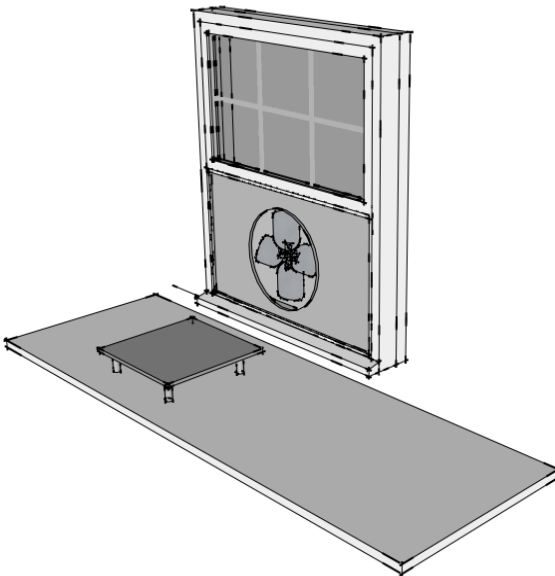

Equipment and Tools

There are a number of tools that you may want. Below is a listing of those items that may be helpful to your practice, but keep in mind that just like any artistic endeavor you don't need everything at once. As you become comfortable with encaustic painting you will have a better understanding of the medium and what specific tools and equipment will work best for you. We suggest the following:

- The heated palette is an essential tool. It provides a surface to heat and mix encaustic paint and medium on. Affordable options include electric skillets, crock-pots, or electric griddles. Regardless of the palette you select, it is important it is equipped with temperature controls.
- A surface thermometer is helpful in monitoring the temperature of your palette (the safe working temperature for encaustic paint ranges from 180-200°F).



Equipment and Tools - continued

- Select suitable fusing tools, such as a heat gun with variable fan speed or a tacking iron. Propane or butane torches can also be used depending on the desired effects. (*Safety Note - Be aware of your surroundings and use caution when using heated tools)
- An assortment of natural bristle brushes (a hake brush is a great all purpose brush). Synthetic brushes can melt when heated.
- Heavy aluminum and steel alloy palette cups are a convenient option to hold larger amounts of paint, medium, and soy wax.
- Various mark-making tools for scraping and carving. Examples include dental tools, etching tools, wood carving tools, clay working tools, razor blades, etc.





Encaustic Paint and Medium

After you have your palette, fusing tools and brushes you will want to have a variety of encaustic paints, encaustic medium, and soy wax for clean-up. Encaustic medium is encaustic paint without pigment. It is used to extend colors and create transparencies.

Clean-up

There are two options for clean-up, either soy or paraffin wax. We recommend using soy wax for clean-up because soybeans are a renewable resource, while paraffin is a petroleum based product. An additional benefit to using soy wax is that it can be washed off with soap and water leaving brushes supple.

To clean brushes, keep a container of soy wax melted on the palette. Pour some on to the palette and work off the paint, using more cleaning wax as needed and blot your paintbrush on newspaper or paper towel.

Supports

For best results, encaustic should be painted on a rigid, absorbent, and heat resistant surface. Examples include: wood (maple or birch plywood), heavy watercolor or printmaking paper glued to board, or raw canvas glued to board (avoid pre-gessoed canvas boards). You can use paper as your support, but you will want to consider the size and rigidity of the paper.

Three-dimensional or sculptural work that is porous and rigid can also be used. Plaster, stone, wood, terra cotta, or cast paper are all acceptable surfaces to work on.

Grounds

For a prepared white ground, we suggest priming with R&F's encaustic gesso, which is specifically formulated for use with this medium. Our high solid acrylic gesso differs from typical acrylic gesso by having a lower proportion of binder to solid making it be more absorbent.

For a convenient primed panel Ampersand and R&F have partnered to introduce Encausticbord™. Encausticbord™ has a ready-to-use surface formulated for the unique demands of encaustic painting and mixed media. Available both unbraced and cradled.



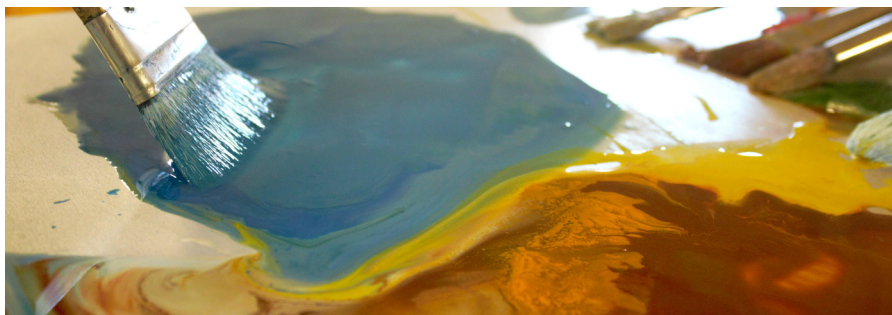

1. First Step - Application

At room temperature encaustic paint is solid. When heated it becomes a workable liquid. In this liquid state it can be brushed on a surface. You can also apply paint on the surface by pouring, dipping, or using heated tools.

Helpful Hints:

- You will want to make sure you are working within a safe temperature of 180-200°F.
- You can melt paint directly on your palette or in palette cups.
- Keep your brushes warm so they remain soft and ready to use. You will find that if you pause with your brush the paint will cool and harden.
- The types of brushes you use will affect the way you apply paint to the surface; a soft hake brush will leave almost no brushstrokes while a bristle brush will.
- If you apply warm paint to a warm panel the paint will flow more readily onto the board, while if you apply warm paint to a cool panel the paint will cool quickly and create texture (see Surface Effects).
- You can heat your support directly on your palette or with the use of a heat gun.

2. Second Step - Layering and Fusing

As you apply layers of paint to your support you will want to fuse (or re-heat) each layer to ensure that it is adhered to your ground or substrate. It is important to fuse between layers to prevent them from separating.

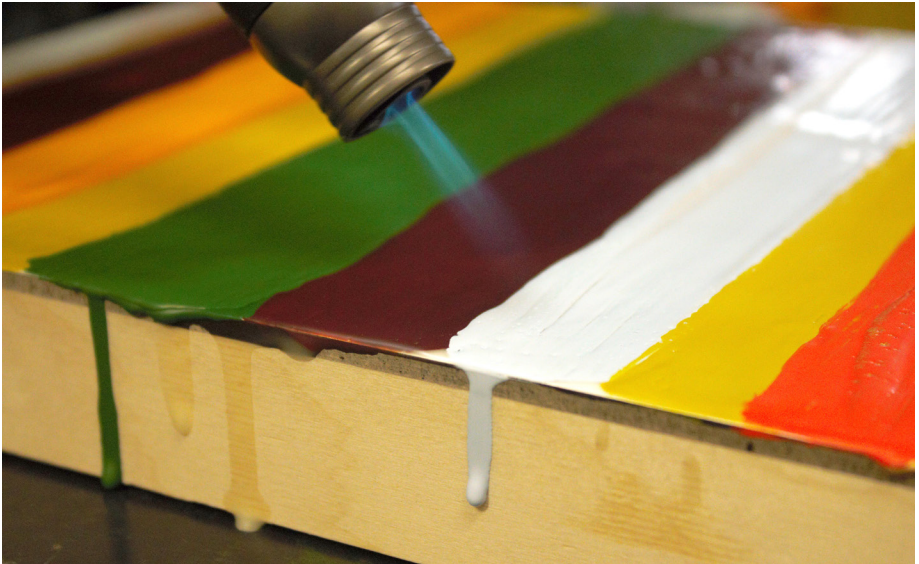

Helpful Hints:

- As you practice fusing you will notice that when the paint begins to glisten or shine that is when it is becoming molten again.
- The cooler a paint has been applied the more thoroughly it should be fused, and visa versa.
- A slow thorough fusing will result in a smooth enamel-like surface.
- If you see air bubbles in the surface of your paint a light fusing with your heat gun's hot air directed at an angle will help to get rid of them.
- Use torches and heat guns to move and manipulate the paint, creating effects that cannot be achieved with a brush.

Indirect Fusing Methods

Indirect fusing refers to heating the surface but not directly touching the physical surface of your painting. Examples would include using a heat gun, torches, light bulbs, or sunlight.

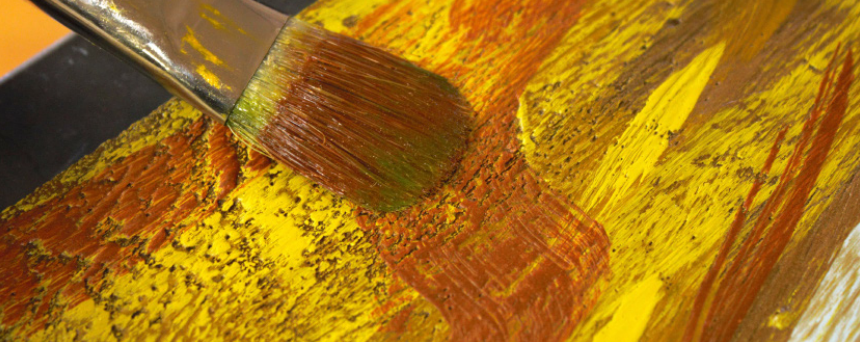

Direct Fusing Methods

Direct fusing refers to touching the surface with a heated tool, which is ideal for creating texture and for modeling the paint. Electric tacking irons, spatulas, and heated brushes provide uninterrupted heating. Plaster tools, palette and paint knives can be heated on the palette. Their diverse shapes give them a great range of mark making ability with differing surface effects.

3. Additional Steps

When the painting has cooled, it has reached its permanent state, but applying paint and fusing are just the beginning.

Reworking the Surface

Thus far, we have explored the additive methods most commonly used working with encaustic, but keep in mind that encaustic painting is also a subtractive medium. If you decide that you want to change your work it can be “erased” by simply scraping off or remelting the paint. There are limitless possibilities when it comes to painting, fusing, and reworking your artwork.

Surface Effects

What uniquely characterizes encaustic is the role heat plays in the process. When the paint is warm and applied to a warm support you will achieve a smooth surface. On the other hand, when you work with paint in a cooler state you will create more texture.

If you want to develop a smooth enamel or glass-like finish:

1. Warm your panel before you begin painting.
2. Use a soft wide brush so that you have even paint coverage.
3. Overlap brushstrokes as little as possible.
3. Slowly and evenly fuse your paint.
4. Gently scrape your layers after you apply them to even out the paint.



To build up a surface with texture:

1. Begin by working with a cool panel and use paint that is at a cooler temperature.
2. Select a bristle brush to exaggerate texture.
3. Use quick overlapping brushstrokes and minimal fusing to build up your surface.
4. Repeat to build the textural surface. Keep in mind that exaggerated textures may be fragile.



Techniques

Layering / Glazing Effects

Glazes can be created by extending a color with medium. They can be applied one on top of another, or separated by layers of straight medium to create unusual translucent effects. Each layer of encaustic should be fused. It is important to consider the opacity and translucency of the paint colors you select in this process. You can build up a high level of relief by continuing to apply layer on top of layer. For variations of surface effects, different degrees of fusing can be employed.

Scraping

As you build up layers of encaustic you can also scrape down to reveal previous layers.

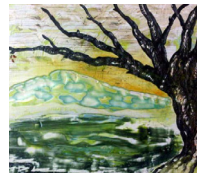

Inlay

A technique where an area of paint (usually a line) is removed and then filled with another paint color.

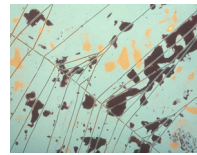

Stenciling

This method blocks off certain areas in preparation for painting.



Assemblage

A benefit to using encaustic is its' adhesive qualities, which allow artists to incorporate a wide range of materials, both 2- and 3-D into their work. (Artwork: Margot Rubin)

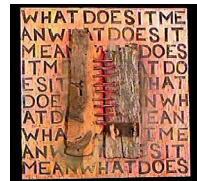

Pouring

A technique that can be used to build up the surface with encaustic without using brushes. (Artwork: Laura Moriarty)

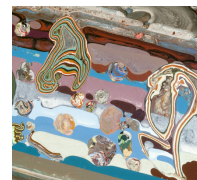

Collage

Beeswax is a natural preservative, making it an ideal material for artists who want to incorporate fragile or nonarchival elements in their work.

(Artwork: Judith Hoyt)



Encaustic Monotype

Images can be created directly on a heated palette and then lifted onto a piece of paper much the same way that a monotype is made in printmaking.

(Artwork: Paula Roland)



Image Transfer Techniques

For those who want to incorporate images, there are several techniques for transferring imagery from paper to an encaustic surface that include graphite and photocopy transfer. (Artwork: Karen Bubb)



Sculptural Applications

Encaustic offers limitless possibilities to artists seeking to work 3-dimensionally. It can be cast, carved, or built-up quickly.

(Artwork: Kim Bernard)



Photography and Book Arts

Combining the encaustic process with traditional and experimental photographic images can create ephemeral effects in artist books.

(Artwork: Cynthia Winika)



R&F Education

As the premier manufacturer of encaustic and **Pigment Sticks®**, R&F Handmade Paints developed a workshop format in 1995 that would introduce artists to fundamental painting techniques in both media. Our aim was to demystify the process for artists, while educating and providing the most up-to-date technical information.

The first workshops offered were our Comprehensive Encaustic Workshops, and many of the students who took them are now among the most popular artists working in the medium today.

Over the years, the reach of our workshops has expanded exponentially and course offerings are now available in a variety of formats and skill levels at various venues throughout the United States and at select international locations. Please check our website at rfpaints.com for the most up to date educational offerings.





R&F Handmade Paints began manufacturing professional artists paints and providing artist-focused technical support in 1988. Today, R&F distinguishes itself by continuing to craft the highest quality paint in small, carefully controlled batches where the eye and skill of the paintmaker are key.

R&F's distinct product line includes two types of paint: our classic wax-based encaustic paint and luscious linseed oil-based Pigment Sticks®.



R&F is unique color.